

8 | 7 | 6 | 5 | 4 | 3 | 2 | 1

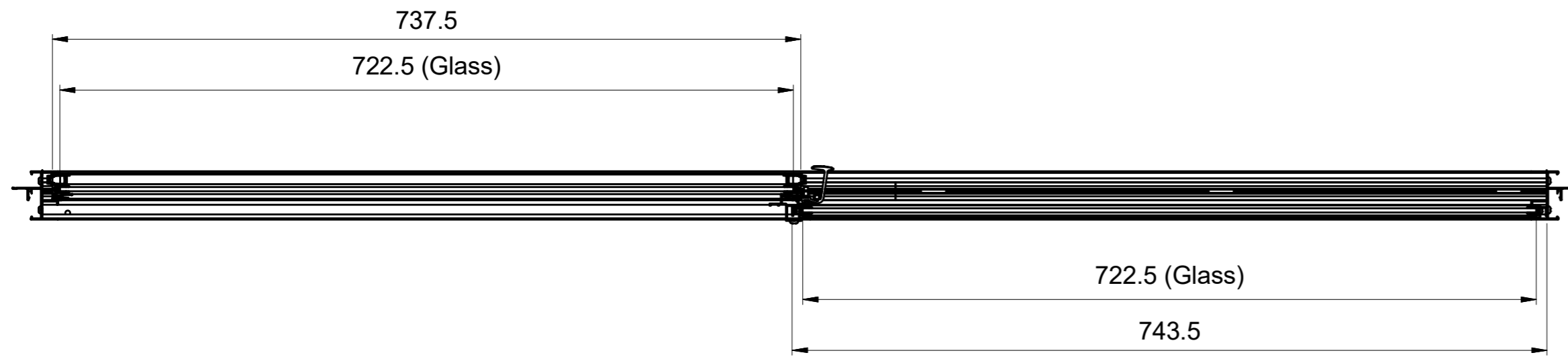

**Section "A" - "A"**

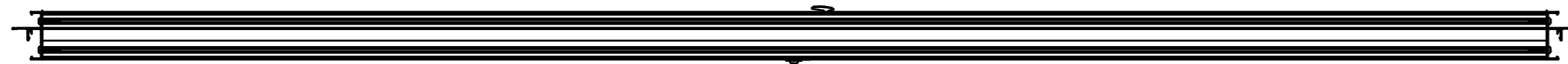

"C"      "B"  
1505

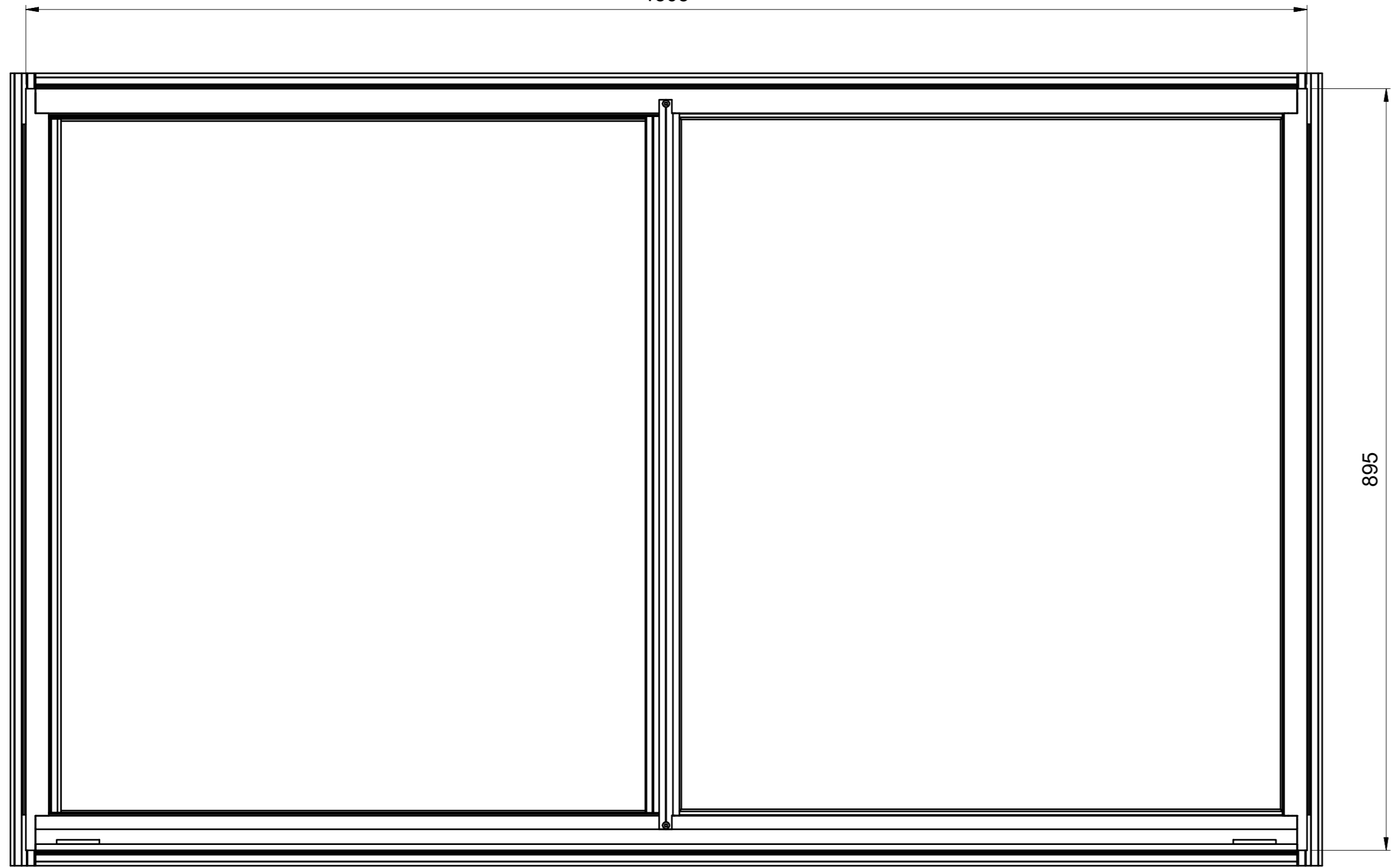

**Sliding Glass Window (895x1505)**

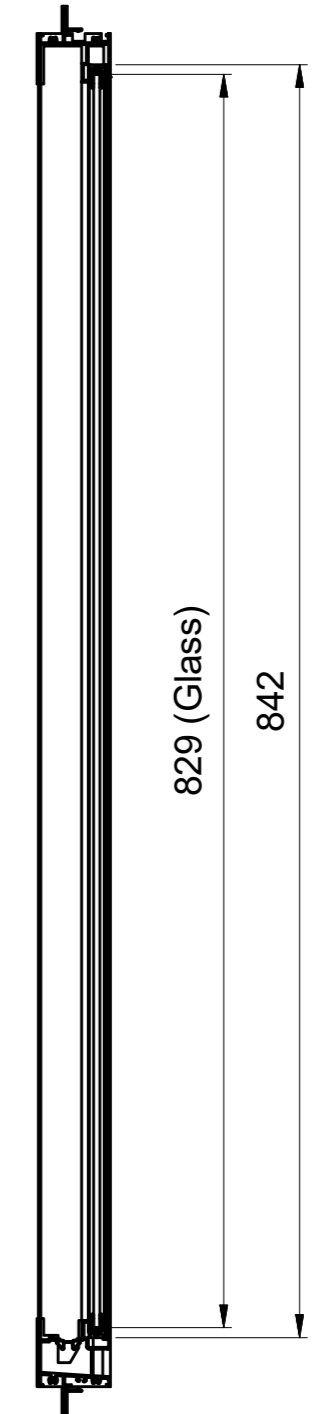

**Section "B" - "B"**



**Section "C" - "C"**

Released



**ADVANCE METAL INDUSTRIES AUSTRALIA**  
 183 Orlando Street COFFS HARBOUR NSW 2450  
 Phone: 02 6652 6955 Fax: 02 6652 3676  
 ABN: 21 566 112 133

DWG TITLE: Sliding Glass Window (895x1505)		ISSUE DATE: 9/06/2021	APPROVAL SENT:
CLIENT:		CHECKED DATE:	APPROVAL DATE:
DRAWN: JMB	CREATED: 9/06/2021	CHECKED BY:	APPROVED BY:
SCALE: PROJECT No.	DRAWING No. SGW-0895x1505-STD		SHEET REV SIZE
1 : 5			1 0 A2

REV	NAME	DATE	DESCRIPTION
0	JMB	9/06/2021	Released

8 | 7 | 6 | 5 | 4 | 3 | 2 | 1

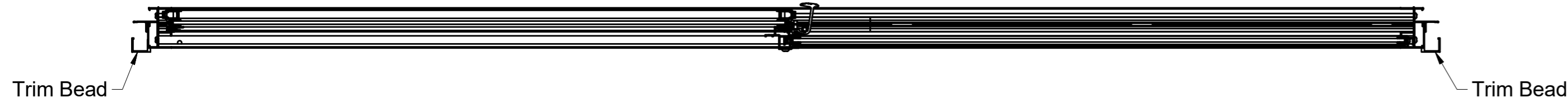

**Section "D" - "D"**

"E"

1544.6

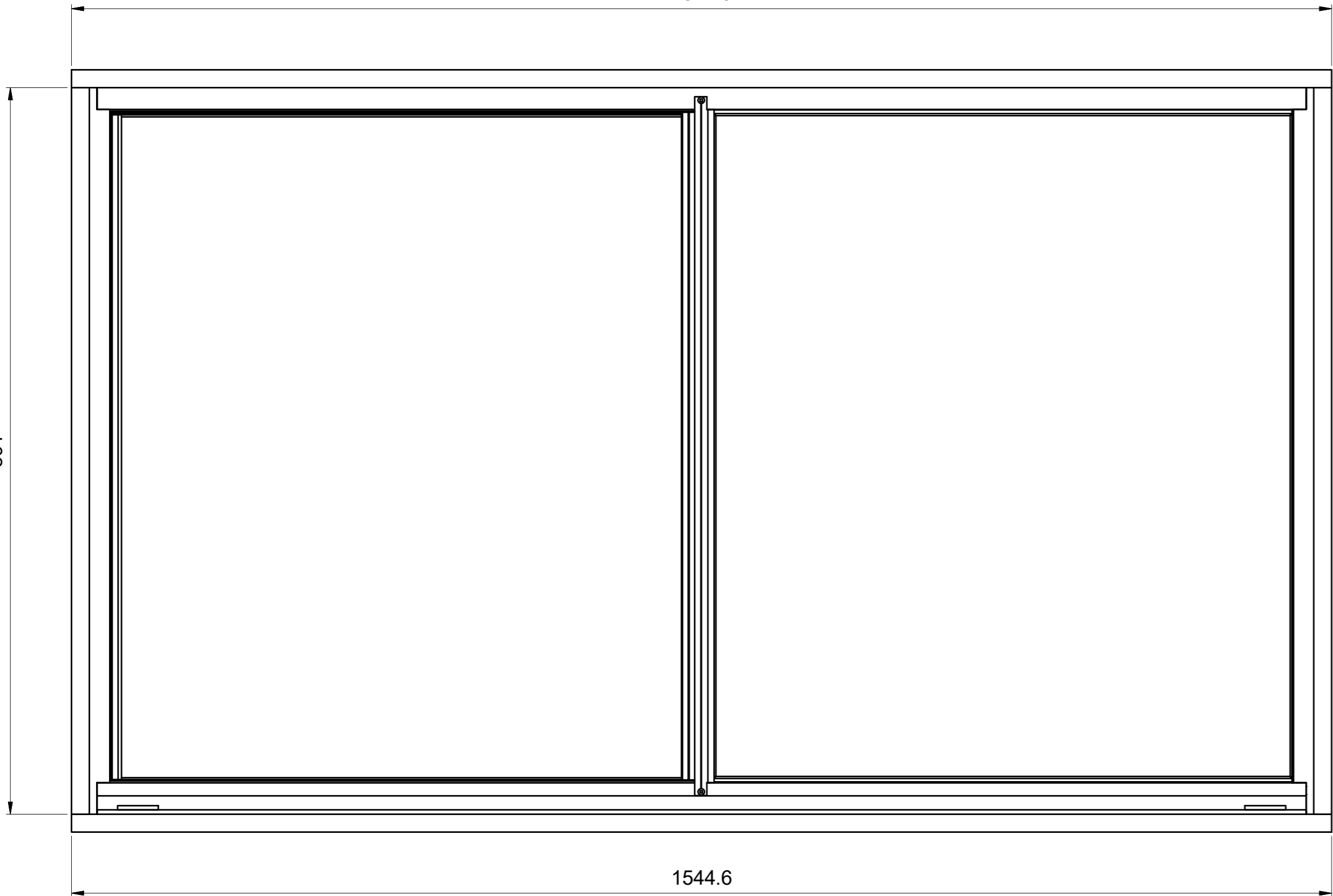

"D"

891

"D"

1544.6

"E"

Trim Bead

Trim Bead

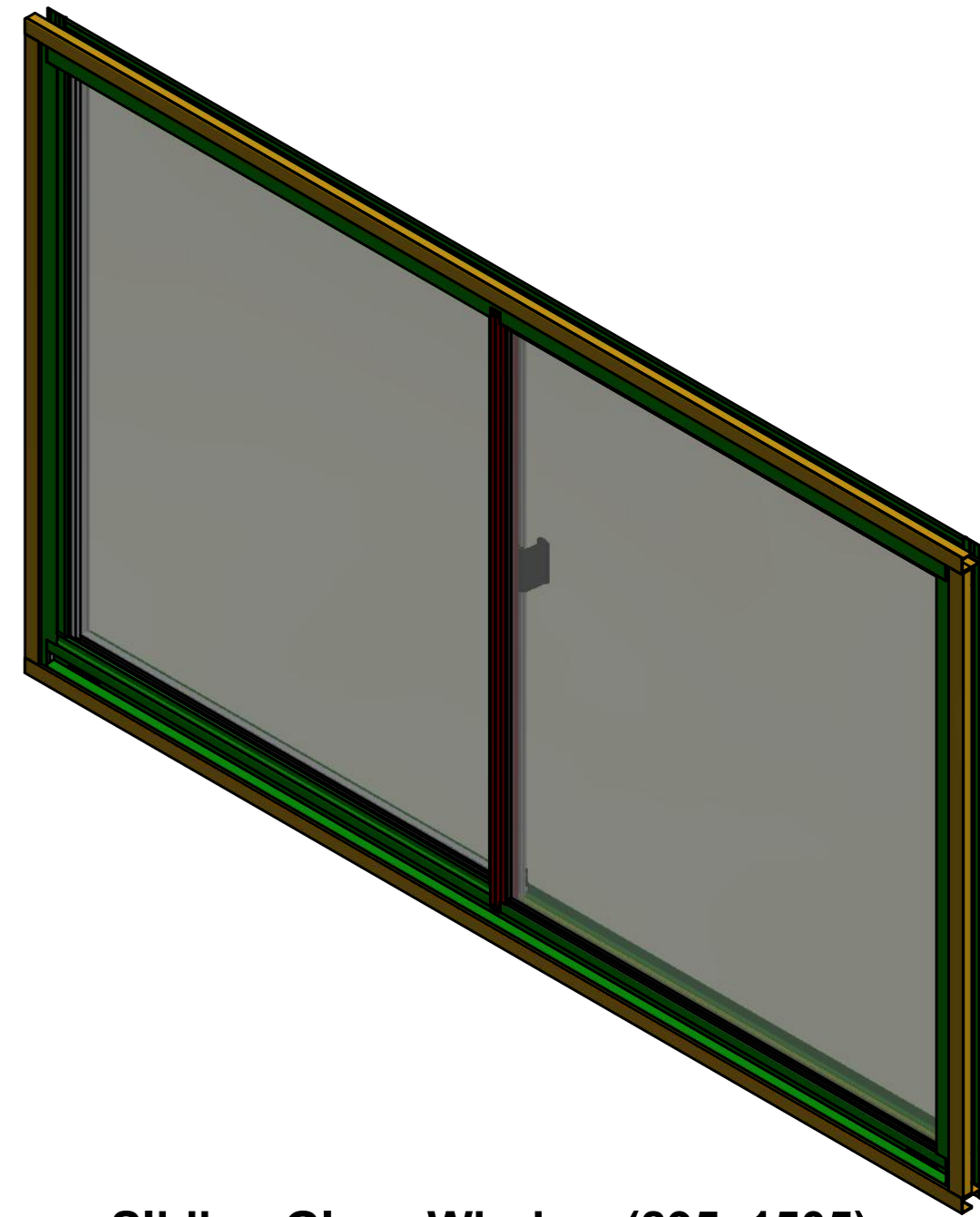

**Sliding Glass Window (895x1505)**

Isometric View

**Section "E" - "E"**

Released

**Sliding Glass Window (895x1505)**

Trim Bead Installed



**ADVANCE METAL INDUSTRIES AUSTRALIA**

183 Orlando Street COFFS HARBOUR NSW 2450

Phone: 02 6652 6955 Fax: 02 6652 3676

ABN: 21 566 112 133

DWG TITLE: Sliding Glass Window (895x1505)		ISSUE DATE: 9/06/2021	APPROVAL SENT:
CLIENT:		CHECKED DATE:	APPROVAL DATE:
DRAWN: JMB	CREATED: 9/06/2021	CHECKED BY:	APPROVED BY:
SCALE: PROJECT No.	DRAWING No. SGW-0895x1505-STD		SHEET REV SIZE
1 : 5			2 0 A2

REV	NAME	DATE	DESCRIPTION
0	JMB	9/06/2021	Released